



ACTUATORS & CONTROLS

Actuation Accessories

Air-Con SV Direct Mount Solenoids

Custom-designed pilot type valves for use with pneumatic actuators.

FEATURES:

- NAMUR Direct Mounting Rapid
- response
- Nickel infused aluminum body Optional
- stainless
- Wide selection of three & four way types
- Voltage 12, 24, 120, 220 available
- NEMA 4 & 7



Limit Switch

ALS Series

Low Cost Compact Design



ALS II Series

Conventional Size Box



Corrosion Resistance
Nickel Infused Housing
Low Profile
Visual Indication

Filter Regulator & Lubricator (Air-Set)

Specification

Operating fluid	Air
Joint pipe bore	1/4" NPT
Filtering element micron	40
Range of adjustable pressure	7.25 - 123.28 psi
Max. adjustable pressure	137.8 psi
Ensured pressure resistance	217.5 psi
Operating temperature range	41 - 140 F
Capacity of filter cup	15 cc
Capacity of oil feed cup	25 cc
Suggested lube	ISO VG 32 or equal
Weight	1.1 lbs
Body material	Aluminum
Container cup material	PE
Protective cup cover material	Iron

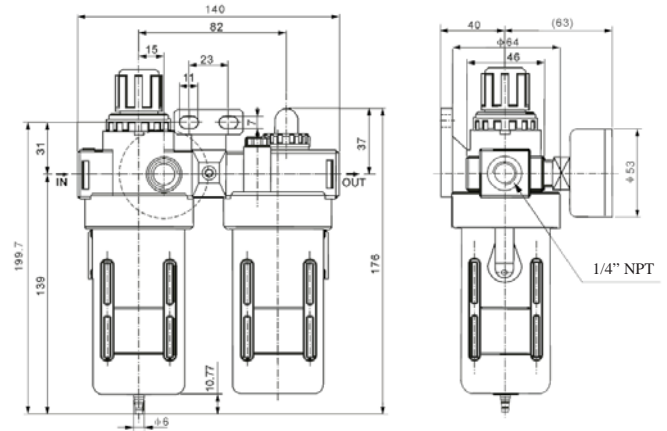
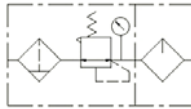

Filter regulator units are available in a wide variety of port sizes to meet a broad range of pneumatic air supply filtration, air regulation and compressed air lubrication applications. It includes two parts: filter/regulator and lubricator, but still has three functions: filtration, decompression, and lubricating.

ISO Square Adapters

Model SQ

Easy - Link's Actuator Inserts are an easy way to mount valves to actuators.



Butterfly Valve Spacer Plates



Easy-Link

Precision Engineered Actuator Mounting Brackets

Features

- 12 design built
- Ten different options
- Fits most valves with ISO 5211 mounting bolt holes
- 304 stainless steel or chrome plated carbon steel

Limit Switch Bracket

Model LS5

Adjustable stainless steel NAMUR Limit Switch Brackets are designed to directly interface with NAMUR standards.

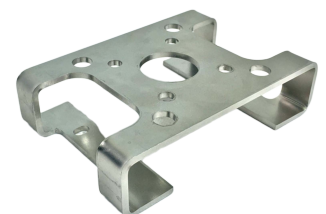
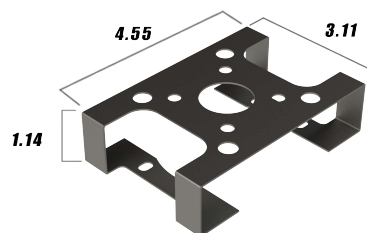

Eazy - Link

Custom Designed Actuator Drive Couplers (from 9 to 46 mm)

Actuator Drive
Blank Coupler



ISO Square
Encapsulated Design



ISO Square
Open Slot



Indicator Series

Highly Visual Position Indicator
mounts to Pneumatic Actuators
with NAMUR standards



Offering a wide selection of options.

Indicators for 90° / Quarter-Turn Valves

Type (open/closed)	Code	Open	Closed
Black / Yellow	Y		
Full Green / Full Red	A		
Full Red / Full Green	B		
ANSI Red / White	R		
ANSI Green / White	G		
ANSI Blue / White	B		

Indicators for Multi-Port Valves (90°)

Type	Code	Views				
		Position 1	Position 2	Position 1	Position 2	
3-way Path O	O			or		
3-way Path T <i>Note: Four Viewing Configurations Possible</i>	T			or		
3-way Path F <i>Note: Four Viewing Configurations Possible</i>	F			or		
4-way Path S	S			or		



Manual Worm Gear Operators

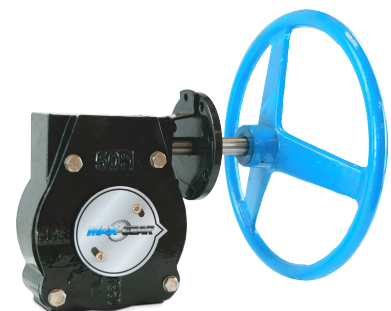

Speed Control Valve Silencer, Muffler, Bug Screen, Breather Vent

In-line
Speed
Controls

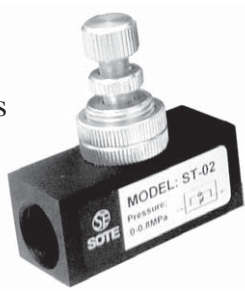

An adjustable needle valve provides metered air flow with the adjustable pressure reducing feature

Speed Controls
& Muffler
Combination



Silencer
Muffler



Bug Screen
Breather Vent



Flexible Stainless
Steel Hose



Hard Stainless
Steel Pipe



Positioners

Flo-Tite Series V200: This is our compact NEMA 4X "all-in-one housing" offered in a pneumatic or electro-pneumatic version. It provides a complete modular design utilizing a rugged, die cast aluminum housing. It is easy to calibrate and both the Zero and Span can be adjusted without removing the cover. This unit provides many options, such as a standard I/P, IS, EX, and others. It also offers a position feedback option in the all-in-one modular housing.

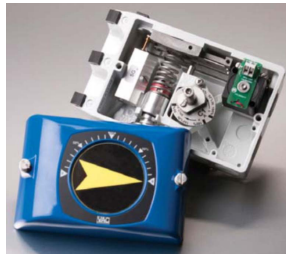

Flo-Tite Series D400: Our microprocessor based, "intelligent" or "smart" positioner can easily be mounted to a vast offering of pneumatic actuators for accurate valve control. This unit is simple to mount and calibrate with its local push-button calibration and LCD onboard monitoring. With properly filtered air, the D400 can provide extremely accurate and trouble-free service for many years. It's available in Hart, Foundation Fieldbus, or Profibus Communications.



Flo-Tite, Inc.
4815 West 5th St.
Lumberton, NC 28358

P. O. Box 1293
Lumberton, NC 28359
Website: www.flotite.com

Tel: (910) 738-8904
Fax: (910) 738-9112
E-mail: flotite@flotite.com