

# VALMATIC®



## Surgebuster® Check Valves



[www.valmatic.com](http://www.valmatic.com)

Designed and Manufactured  
to AWWA C508  
NSF/ANSI 61 Certified  
NSF/ANSI 372 Certified

# Feature Highlights

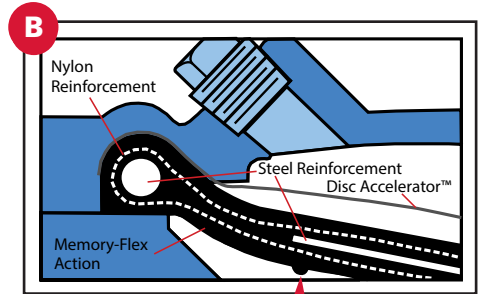
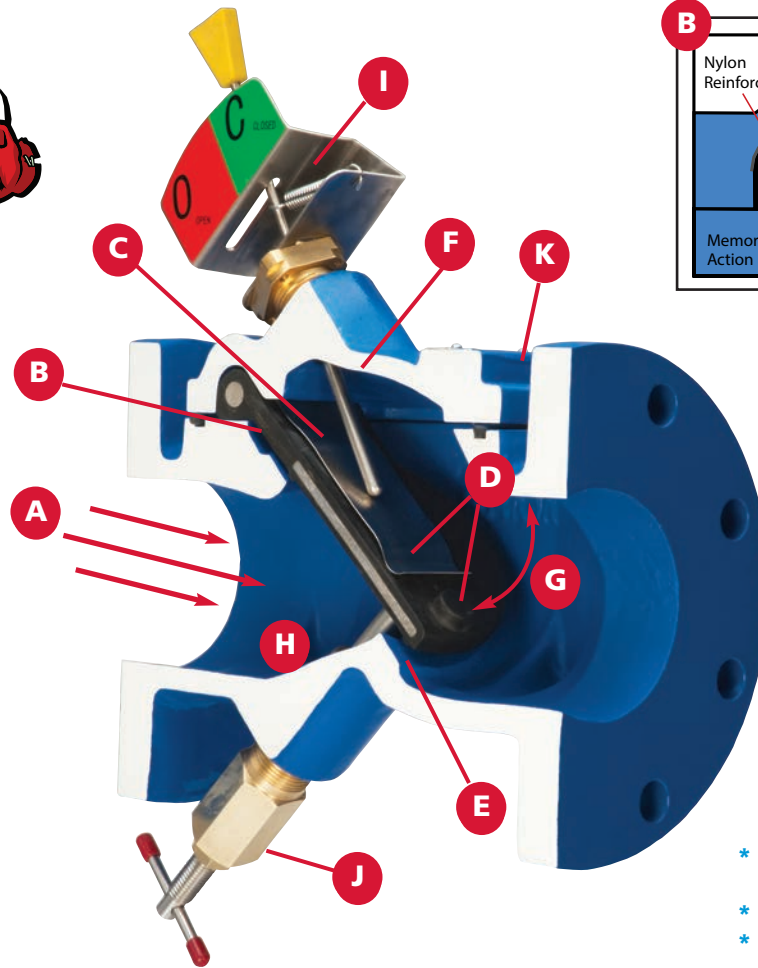
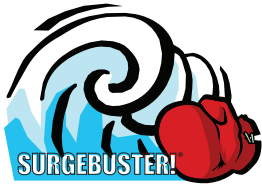

## A. Non-Clog Design

100% flow area for improved flow characteristics and lower headloss. Unrestricted flow area combined with smooth streamlined contouring allows passage of large solids minimizing the potential for clogging.

## B. Reinforced Disc

The one piece precision molded disc is steel and nylon reinforced to provide years of trouble free performance. It is backed by a 25 year warranty for the flex portion of the disc.

## C. Disc Accelerator™

The signature Surgebuster® Disc Accelerator™ moves in perfect tandem with the reinforced disc to quickly and efficiently speed the closure of the disc.

## D. Two Moving Parts

The Memory-Flex™ disc and the Disc Accelerator™ are the only moving

parts. There are no packing, mechanical hinges, pivot pins or bearings to wear out. Hinge portion of the disc is warranted for 25 years.

## E. Drop Tight Seating

The synthetic reinforced disc, with its integral O-ring type seal design assures positive seating at high and low pressures.

## F. Domed Access Port

Full size top access port allows removal of disc without removing the valve from the line and provides flushing action over the valve disc for clog free performance. Access cover includes a drilled and tapped port for installation of optional Disc Position Indicator.

## G. Non-Slam Closure

"Short Disc Stroke" combined with Memory-Flex™ Disc Action and Disc Accelerator™ to reduce potentially destructive water hammer.

- \* Designed and Manufactured to AWWA C508
- \* NSF/ANSI 61 Certified
- \* NSF/ANSI 372 Certified

## H. Fusion Bonded Epoxy

Fusion Bonded Epoxy (FBE) is the standard coating on the interior and exterior of the valve to provide superior corrosion and wear resistance.

## I. Mechanical Disc Position Indicator

Provides clear indication of the valve's disc position. Can also be provided with a SCADA compatible limit switch for off site monitoring. (Optional)

## J. Backflow Actuator

Body is drilled and tapped for installation of backflow actuator. Available for use when manual backflow operation is required. Most commonly used for priming pumps, back flushing, draining lines and system testing. (Optional)

## K. Cover Bolts

Bolting is stainless steel for corrosion resistance in harsh environments.

# Features & Benefits

## Innovative Design

Pumping applications with high head, surge tanks, or multiple pumps, have long proved a challenge to system operators trying to minimize line surges resulting from slamming check valves.

Only one real cause exists for slamming check valves -- reverse flow. The impact of the reverse flow is direct and proportional; the faster the reverse flow, the more violent the slam. If reverse flow through the check valve is allowed to develop, the reverse flow will slam the disc into the seat and create a loud water hammer or surge. Now system operators have the solution...Surgebuster®.

## Optimum Performance

The Surgebuster® achieves rapid closure through a short disc stroke of 35° and adjustable Disc Accelerator™. The short disc stroke is less than half the typical 80° to 90° stroke of a conventional swing check valve. It is achieved by placing the valve seat on a 45° angle while maintaining a full flow area equal to the mating pipe (Figures 1 & 2).

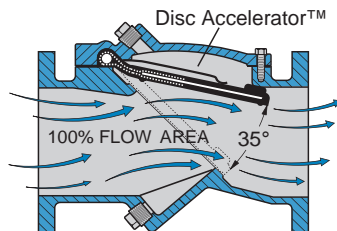

Figure 1. Val-Matic Surgebuster® Valve

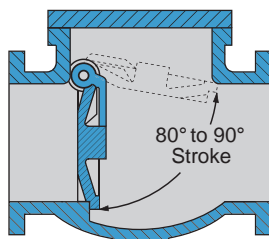

Figure 2. Conventional Swing Check Valve

The Disc Accelerator™ is a precision formed stainless steel mechanism that closes the valve disc rapidly thus avoiding slamming by flow reversal and allowing the disc to be stabilized under flow conditions. The accelerator is fully enclosed within the valve and completely out of the flow path (Figure 1).

Traditional swing check valves use outside levers with weights or springs in an attempt to reduce slam. By doing so, they force the disc into the flow and reduce the length of the disc stroke so that it closes faster.

Unfortunately, while outside levers and weights help solve one problem, they create two others. Increased headloss and maintenance are inevitable with traditional swing check valves. Pulling the disc down into the flow creates a blockage in the line and causes tremendous headloss and turbulence. With the disc oscillating in the flow, the shaft, bearings, and shaft seal are all subjected to increased wear and reduced service life.

In many applications, this approach has proven ineffective and led to the addition of an air cushion cylinder, which is attached to the weight or spring powered lever. Conversely, the traditional air cushion slows the disc travel allowing reverse flow to increase. The end result, especially on fast flow reversal systems, is a slamming check valve and water hammer.

The Surgebuster® with its short 35° stroke and Disc Accelerator™ provide fast closure thereby preventing slam and the resultant surge without obstructing flow or the need for maintenance. Val-Matic is so confident in the Surgebuster's non-slam performance that we guarantee\* the valve will out perform any air cushion swing check valve with weight and lever.

## Advanced Technology

Incorporating the latest in valve technology assures a high-quality valve that will provide long service. The design process utilized solid Modeling and Finite Element Analysis (FEA) of the key structural components. Flow and headloss data was derived from flow tests, mathematical models and Computational Fluid Dynamics (CFD). Manufacturing technology uses automated process control in the foundry and ISO 9001 controlled manufacturing processes.

## Product Certifications

Val-Matic Surgebuster® check valves are certified for use in drinking water in accordance with NSF/ANSI 61 and are Certified Lead-Free per NSF/ANSI 372. All valves are tested on automated hydraulic test rigs with gauges calibrated per ISO standards. All Val-Matic Valves are manufactured under a certified ISO 9001 quality management system.

\* Warranty details available upon request.

# Ratings/Construction

## PRESSURE RATINGS

MAXIMUM PRESSURE RATINGS		
SIZE RANGE in (mm)	CONNECTION	CWP psig (Bar)
2" - 24" (50-600 mm)	ANSI Class 125 Ductile Iron	250 (17.2)
30" - 48" (800-1200 mm)	ANSI Class 125 Cast Iron	150 (10.3)
30" - 48" (800-1200 mm)	ANSI Class 125 Ductile Iron	250 (17.2)

## MATERIALS OF CONSTRUCTION

COMPONENT	STANDARD	OPTIONAL
Body 2" - 24" (50-600 mm)	Ductile Iron ASTM A536, Grade 65-45-12	ASTM A351, CF8M 316 SS 3"-12" (80-300 mm)
Body 30" - 48" (800-1200 mm)	Ductile Iron ASTM A536, Grade 65-45-12	Cast Iron ASTM A126, Class B
Disc	Buna-N w/Alloy Steel & Nylon Reinforcement	EPDM, Hypalon, Viton
Disc Accelerator	ASTM A666 T302 Stainless Steel	-
Coatings	Fusion Bonded Epoxy (Int/Ext)	Rubber Lining, Glass Lining
Mechanical Indicator (Optional)	17-4 Stainless Steel, Lead-Free Bronze	-
Backflow Actuator (Optional)	17-4 Stainless Steel, Lead-Free Bronze	-

AWWA Note: If the purchaser specifies a wetted component that was not tested and certified to NSF/ANSI 61, the certification may not be valid.

# Headloss Chart

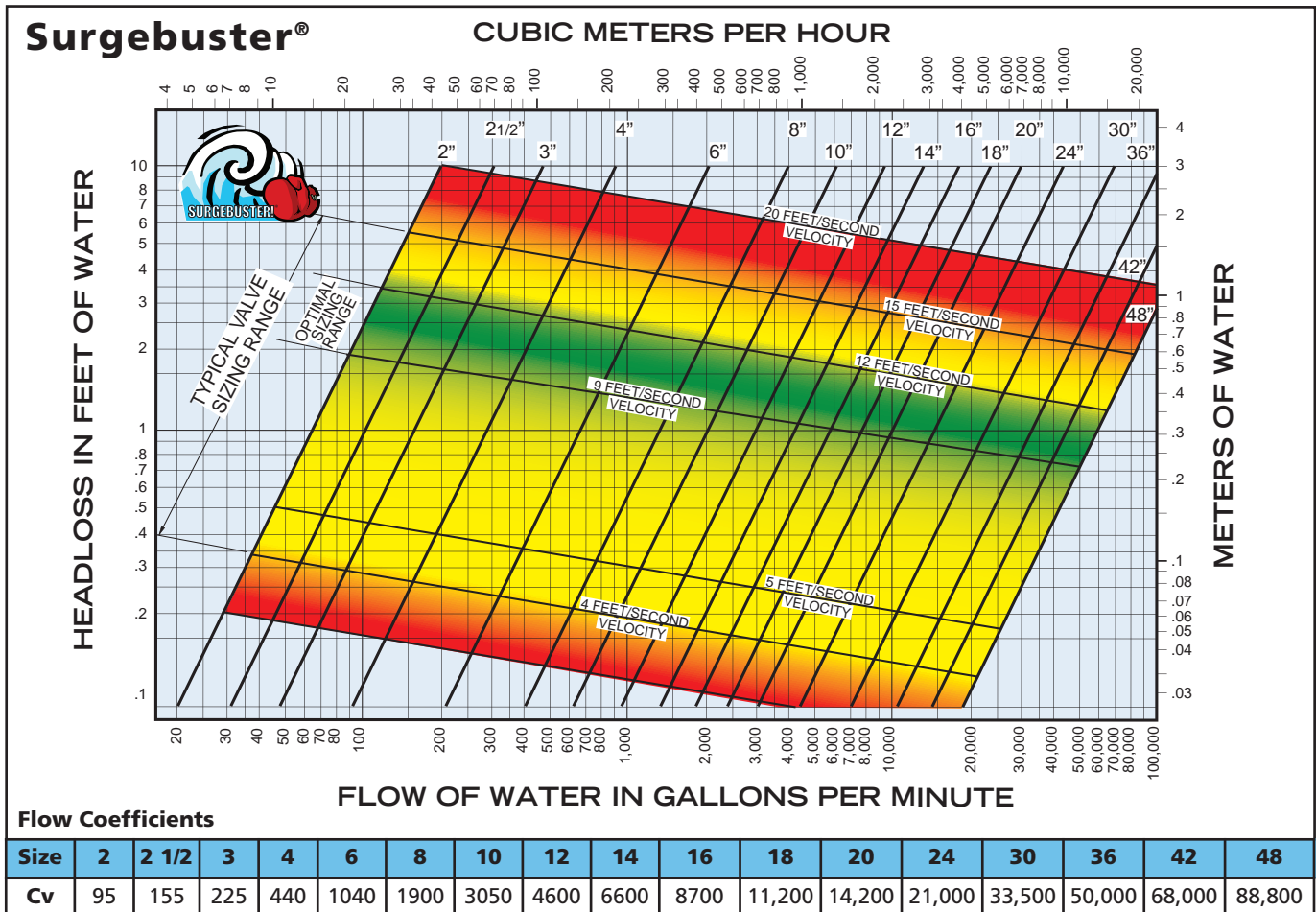

# Installation Dimensions

Series 7200 w/Mechanical Indicator  
& Backflow Actuator

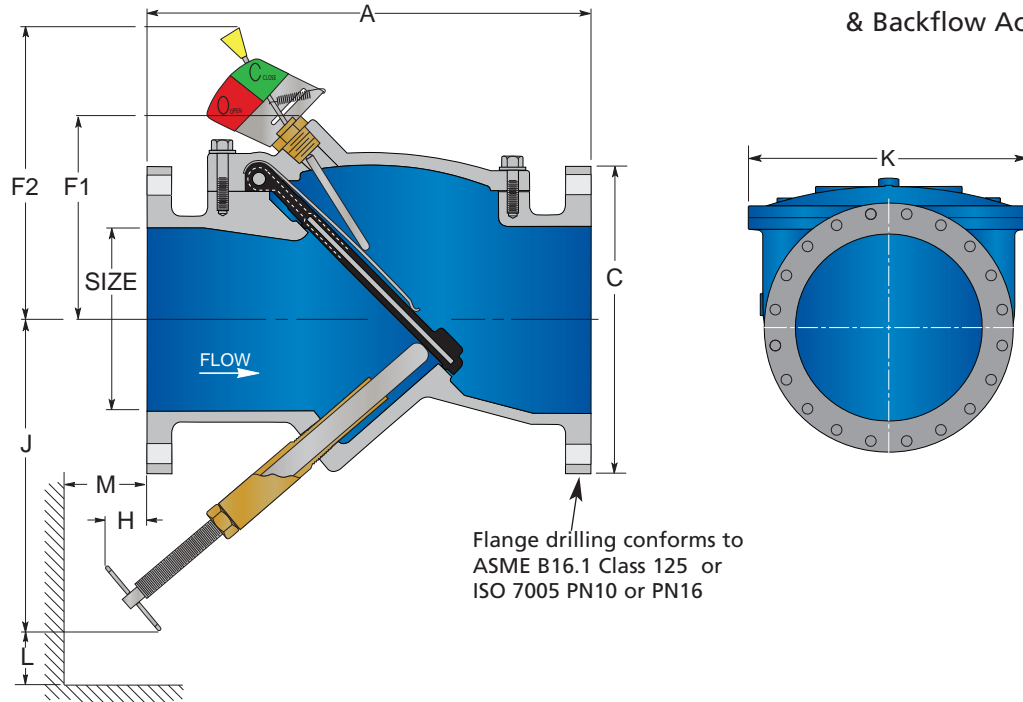

Dimensions in Inches

Valve Size (in)	Valve Size (mm)	CWP (PSI)	Base Valve				with Indicator	with Backflow Actuator				
			Model No.	A	C	F1	K	F2	H	J	L	M
2	50	250	7202	8.00	6.00	3.38	5.18	-	-0.50	6.75	1.50	1.50
2 1/2	60	250	7225	8.50	7.00	3.38	5.18	-	-0.50	7.00	1.50	1.50
3	80	250	7203	9.50	7.50	5.13	7.50	8.88	-0.38	7.50	1.50	1.50
4	100	250	7204	11.50	9.00	5.75	8.25	9.50	3.38	10.75	2.50	2.50
6	150	250	7206C	14.00	11.00	6.88	11.13	10.63	1.38	11.38	3.00	3.00
8	200	250	7208	19.50	13.50	8.38	16.00	12.25	2.00	15.75	5.75	5.75
10	250	250	7210	24.50	16.00	10.75	21.00	14.63	0.50	17.00	5.75	5.75
12	300	250	7212	27.50	19.00	12.50	24.00	16.25	3.50	22.50	6.50	6.50
14	350	250	7214	31.00	21.00	13.00	23.25	18.88	4.00	26.25	6.50	6.50
16	400	250	7216C	36.00	23.50	14.25	25.25	20.13	4.63	30.00	6.50	6.50
18	450	250	7218C	40.00	25.00	15.25	28.25	21.25	5.25	33.75	6.50	6.50
20	500	250	7220	40.00	27.50	16.88	30.63	22.63	5.88	37.50	8.00	8.00
24	600	250	7224	48.00	32.00	19.25	36.00	25.13	1.81	45.00	8.00	8.00
30	800	150	7230	56.00	38.75	23.00	45.88	28.88	-0.63	41.25	8.00	8.00
	800	250	7230A									
36	900	150	7236	63.00	46.00	27.38	55.00	32.25	-0.38	49.00	9.75	9.75
	900	250	7236A									
42	1000	150	7242	70.00	53.00	36.88	60.18	40.37	-5.50	53.50	9.75	9.75
	1000	250	7242A									
48	1200	150	7248	76.00	59.50	40.66	68.00	43.41	-2.90	41.98	10.00	10.00
	1200	250	7248A									

# Dynamic Testing of Check Valves

Surgebuster® and Conventional Air Cushioned Swing Check Valves were flow tested under identical dynamic conditions and the downstream pressure plotted as shown in Figures 1 and 2. The valves were installed on the discharge of a four-inch 20 HP water pump and connected to a hydro-pneumatic tank charged to 30 psig. After pump shutdown, the water flow would rapidly reverse in about 1/2 second and cause rapid valve closure.

The Air Cushioned Swing Check Valve was equipped with a lever, weight and air cushion with flow control valve. Despite an operating velocity over 8 feet per second, the Cushioned Swing Check Valve traveled only 15° or about 25% open. Partially open check valves are common and can cause excessive headloss and energy consumption. Adjustments to the air cushion slowed down the valve closure and magnified the valve slam. In Figure 1, the valve closed with a loud

slam and produced an upsurge in the downstream piping of 150 psi over the static pressure.

The Surgebuster® was operated under the same flow conditions and was found to open 35° or 100% open. In Figure 2, after pump shutdown the Surgebuster® closed with a negligible slam and produced an upsurge in the downstream piping of only 25 psi over the static pressure.

The dynamic tests demonstrate that the Surgebuster® can reduce check valve slam up to 80% when compared to conventional swing check valves. Numerous field installations with vertical lines, multiple pumps, and high pump discharge head all exhibited the same result. The Surgebuster® provides non-slam operation with reduced headloss and maintenance.

\*Video test results available at [www.valmatic.com](http://www.valmatic.com).

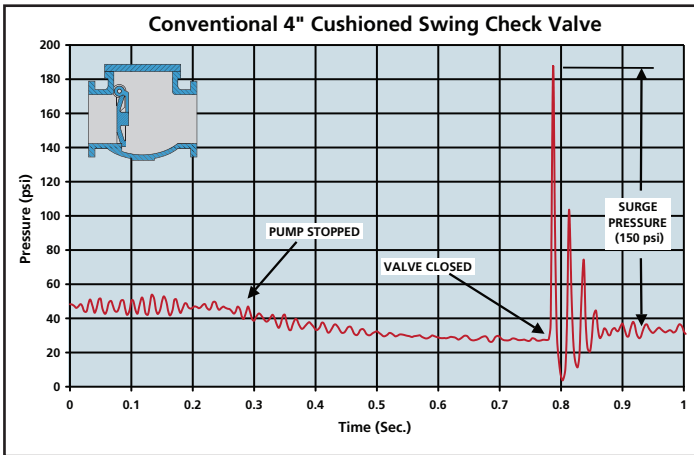

Figure 1. The conventional air cushioned swing check valve closed with a loud slam producing a 150 psi surge with optimum cushion adjustment.

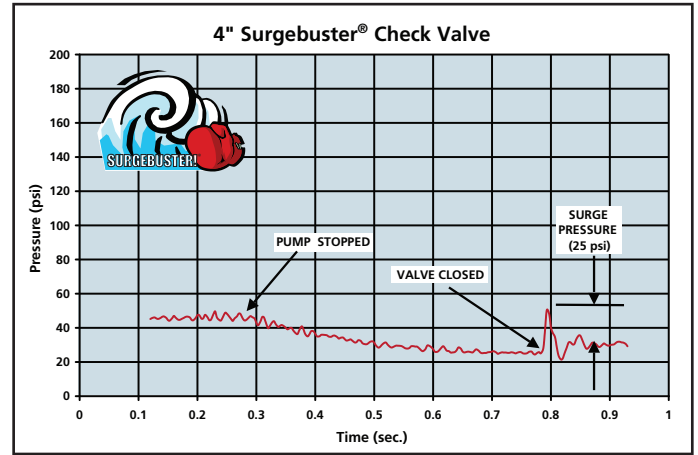









Figure 2. The Surgebuster® closed quietly producing a 25 psi surge pressure, 80% less than the conventional air cushioned swing check valve.

## Options/Accessories

Mechanical Disc Position Indicator	Limit Switch	Check Light	Backflow Actuator	Welded Nickel Seat	Tapped Ports	Rubber Lining	Glass Lining
Provides clear indication of the valve's disc position.	Used when applications require remote indication of valve's open/close position.	Provides remote indication from the limit switch.	Available for use when manual backflow operation is required.	For severe and abrasive service.	Top and bottom NPT ports for sampling, pressure testing, and removing sediment.	Interior lining suited for systems containing abrasive or corrosive fluids.	Interior lining provides a smooth, non-stick surface.
							

## SCOPE

- 1.1 This specification covers the design, manufacture, and testing of 2 in. (50 mm) through 48 in. (1200 mm) Surgebuster® Swing Check Valves suitable for cold working pressures up to 250 psig (1725 kPa), in water, wastewater, abrasive, and slurry service.
- 1.2 The check valve shall be of the full flow body type, with a domed access cover and only two moving parts, the flexible disc and the Disc Accelerator™.

## STANDARDS AND APPROVALS

- 2.1 The valves shall be designed, manufactured and tested to American Water Works Association Standard ANSI/AWWA C508.
- 2.2 The valves used in potable water service shall be certified to NSF/ANSI 61 Drinking Water System Components – Health Effects, and certified to be Lead-Free in accordance with NSF/ANSI 372.
- 2.3 Manufacturer shall have a quality management system that is certified to ISO 9001 by an accredited, certifying body.

## CONNECTIONS

- 3.1 The Valves shall be provided with flanges drilled in accordance with ANSI B16.1, Class 125.

## DESIGN

- 4.1 The valve body shall have a full flow area equal to nominal pipe area at all points through the valve. The 4 in. (100mm) valve shall be capable of passing a 3 in. (75mm) solid. The seating surface shall be on a 45 degree angle to minimize disc travel. A threaded port with pipe plug shall be provided on the bottom of the valve to allow for field installation of a backflow actuator or oil cushion device without special tools or removing the valve from the line.
- 4.2 The top access port shall be full size, allowing removal of the disc without removing the valve from the line. The access cover shall be domed in shape to provide flushing action over the disc for operating in lines containing high solids content. A threaded port with pipe plug shall be provided in the access cover to allow for field installation of a mechanical, disc position indicator.
- 4.3 The disc shall be of one-piece construction, precision molded with an integral O-ring type sealing surface and reinforced with alloy steel. The flex portion of the disc shall contain nylon reinforcement and shall be warranted for twenty-five years. Non-Slam closing characteristics shall be provided through a short 35 degree disc stroke and a disc accelerator to provide a cracking pressure of 0.3 psig.
- 4.4 The disc accelerator shall be of one piece construction and provide rapid closure of the valve in high head applications. The disc accelerator shall be enclosed within the valve and shall be field adjustable and replaceable without removal of the valve from the line. The disc accelerator shall be securely held in place captured between the cover and disc. It shall be formed with a large radius to allow smooth movement over the disc surface.
- 4.5 The valve disc shall be cycle tested 1,000,000 times in accordance with ANSI/AWWA C508 and show no signs of wear, cracking, or distortion to the valve disc or seat and shall remain drop tight at both high and low pressures.

## MATERIALS

- 5.1 The valve body and cover shall be constructed of ASTM A536 Grade 65-45-12 ductile iron or ASTM A126 class B gray iron for 30 in. (800mm) and larger. Optional body materials include ASTM A-351 Grade CF8M, stainless steel for sizes 3" (80 mm) through 12" (300 mm).
- 5.2 The disc shall be precision molded Buna-N (NBR), ASTM D2000-BG. Optional disc material includes Viton, EPDM, Hypalon.
- 5.3 The disc accelerator shall be Type 302 stainless steel.

## OPTIONS

- 6.1 A screw-type backflow actuator shall be provided (when specified) to allow opening of the valve during no-flow conditions. Buna-N seals shall be used to seal the stainless steel stem in a Lead-Free bronze bushing. The backflow device shall be of the rising-stem type to indicate position. A stainless steel T-handle shall be provided for ease of operation.
- 6.2 A mechanical indicator shall be provided (when specified) to provide disc position indication on valves 3" (80 mm) and larger. The indicator shall have continuous contact with the disc under all operating conditions to assure accurate disc position indication.
- 6.3 A pre-wired limit switch will be provided (when specified) to indicate open/closed position to a remote location. The mechanical type limit switch shall be activated by the mechanical indicator. The switch shall be rated for NEMA 4, 6, or 6P and shall have U.L. rated 5 amp, 125 or 250 VAC contacts.
- 6.4 Available linings include rubber for abrasive or corrosive fluids and glass for a smooth, non-stick surface.
- 6.5 A welded nickel seat is available for severe or abrasive service.

## MANUFACTURE

- 7.1 Manufacturer shall demonstrate a minimum of five (5) years' experience in the manufacture of resilient, flexible disc check valves with hydraulic cushions.
- 7.2 All valves shall be hydrostatically tested and seat tested to demonstrate zero leakage. When requested, the manufacturer shall provide test certificates, dimensional drawings, parts list drawings, and operation and maintenance manuals.
- 7.3 The exterior and interior of the valve shall be coated with an NSF/ANSI 61 approved fusion bonded epoxy coating.
- 7.4 Surgebuster® Swing Check Valves shall be Series #7200 as manufactured by Val-Matic® Valve & Mfg. Corporation, Elmhurst, IL. USA or approved equal.



Val-Matic's quality of design and meticulous workmanship has set the standards by which all others are measured. Quality design features such as the AWWA **Ener-G® Ball Valve** with its energy efficient design, fusion bonded epoxy and adjustable resilient seating....**Cam-Centric® Plug Valves** have more requested features than any other eccentric plug valve....**American-BFV® Butterfly Valves** include a field replaceable seat without the need for special tools....**Tilted Disc® Check Valves** with high strength and wear resistant aluminum bronze trim as standard....**Silent Check Valves** featuring combined resilient/metal-to-metal seating and are **NSF/ANSI 61 & 372 Certified**....**Sure Seal Foot Valves** provided with a heavy duty stainless steel screened inlet....**Swing-Flex® and Surgebuster® Check Valves** designed with an unrestricted full flow area....**Swing Check Valves** with field adjustable closure

versatility....**Dual Disc® Check Valves** utilizing stabilized components to provide extended life....**Air Release, Air/Vacuum and Combination Air Valves** provided standard with Type 316 stainless steel trim....**VaultSafe®** family of products includes the **FloodSafe® Inflow Preventer**, **FrostSafe®** two-way damper and the **VentSafe®** vent pipe security cage. The **QuadroSphere® Trunnion Ball Valve** features a unique ball design with recessed surfaces creating additional flow paths to provide a self-cleaning action and reduced wear and torque.

Val-Matic is totally committed to providing the highest quality valves and outstanding service to our customers. Complete customer satisfaction is our goal. **Make the change to quality, specify Val-Matic!**



**Val-Matic Valve and Manufacturing Corp.**  
 905 Riverside Drive, Elmhurst, IL 60126  
 Phone: 630-941-7600 • Fax: 630-941-8042  
 www.valmatic.com • valves@valmatic.com

Copyright © 2018 Val-Matic Valve & Mfg. Corp. 6/18  
 ISO 9001:2015 certified company