

# VALMATIC®



## Swing-Flex® Check Valves



[www.valmatic.com](http://www.valmatic.com)

Designed and Manufactured  
to AWWA C508  
NSF/ANSI 61 Certified  
NSF/ANSI 372 Certified

# Feature Highlights

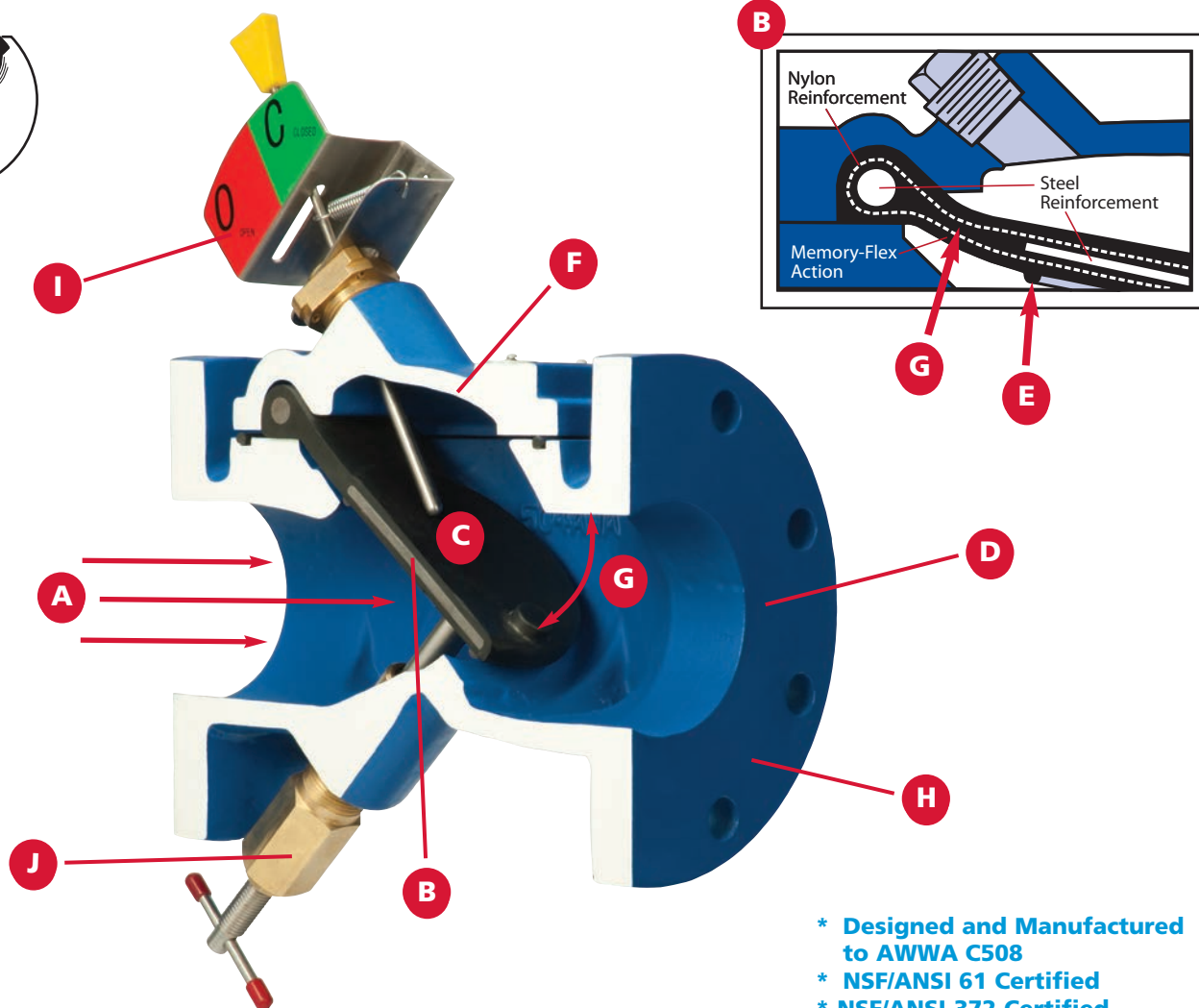

- \* Designed and Manufactured to AWWA C508
- \* NSF/ANSI 61 Certified
- \* NSF/ANSI 372 Certified

## A. Non-Clog Design

100% flow area for improved flow characteristics and lower headloss. Unrestricted flow area combined with smooth streamlined contouring allows passage of large solids minimizing the potential for clogging.

## B. Reinforced Disc

The one piece precision molded disc is steel and nylon reinforced to provide years of trouble free performance. It is backed by a 25 year warranty for the flex portion of the disc.

## C. One Moving Part

The Memory-Flex™ disc, the only moving part, assures long life with minimal maintenance. No packing, mechanical hinges, pivot pins or bearings to wear out.

## D. Body

Ductile Iron Body for 250 PSI rating.

## E. Drop Tight Seating

The synthetic reinforced disc, with its integral O-ring type seal design assures positive seating at high and low pressures.

## F. Domed Access Port

Full size top access port allows removal of disc without removing the valve from the line and provides flushing action over the valve disc for clog free performance. Access cover includes a drilled and tapped port for installation of optional Disc Position Indicator (I).

## G. Non-Slam Closure

“Short Disc Stroke” combined with Memory-Flex™ Disc Action reduces potentially destructive water hammer.

## H. Fusion Bonded Epoxy

Fusion Bonded Epoxy (FBE) is the standard coating on the interior and exterior of the valve. The FBE is NSF/ANSI 61 certified.

## I. Mechanical Disc Position Indicator

Provides clear indication of the valve’s disc position. Can also be provided with a SCADA compatible limit switch for off site monitoring. (Optional)

## J. Backflow Actuator

Body is drilled and tapped for installation of backflow actuator. Available for use when manual backflow operation is required. Most commonly used for priming pumps, back flushing, draining lines and system testing. (Optional)

# Features & Benefits

## Proven Design

Efficiency and reliability through simplicity of design is the key to the superior performance and long life of the Val-Matic Swing-Flex® Check Valve. The streamlined contour of the Swing-Flex® body provides 100% flow area with no restrictions at any point through the valve (Figure 1). Flow tests performed by the Utah State Water Research Laboratory have shown that this unique body design produces minimal headloss through the valve. Flow and headloss charts, developed from the test data, are shown on Page 4.

In the full open position, the disc is stabilized by using smooth streamlined body contouring to direct the flow towards the disc preventing disc flutter and assuring long disc life (Figure 1). Clog resistant performance is achieved by maintaining an unobstructed 100% flow area and the use of a smooth fusion bonded epoxy coating. The entrapment or collection of solids and stringy materials is minimized by the elimination of hinge mechanisms in the valve design. The standard 4" Swing-Flex® is designed to pass a 3" solid.

## Preferred Features

The Swing-Flex® Check Valve non-slam closing characteristic is achieved by utilizing a "Short Disc Stroke" in conjunction with the unique "Memory-Flex™ action" of the valve's disc. The 35° stroke, a result of the angled seat, is less than half the typical 80° to 90° stroke of a conventional swing check valve. (Figures 1 & 2)

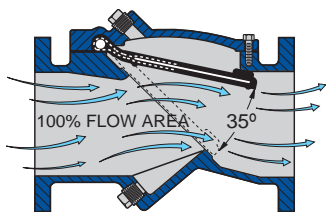

Figure 1. Swing-Flex Geometry

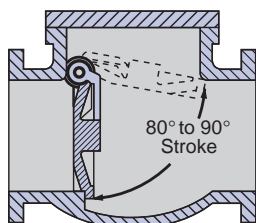

Figure 2. Conventional Geometry

The short disc stroke and "Memory-Flex™ action" (Figure 1) serve to reduce the closing time of the valve

minimizing flow reversal and the resultant water hammer normally associated with the sudden stoppage of reverse flow.

Operational reliability is achieved by utilizing just one moving part, the Memory-Flex™ disc. The steel and nylon reinforcements are precision molded into the disc, providing a tough, durable disc with a 25-year warranty on the flex portion of the disc (Figure 3). Unlike conventional swing check valves, the Swing-Flex® has no packing, mechanical hinges, shafts, pivot pins, or bearings to wear out. The Memory-Flex™ disc with its integral O-ring type seal design assures drop tight seating at both high and low working pressures. Upon conclusion of a 1,000,000 (one million) cycle test, an independent testing laboratory reported that the valve had no visible signs of wear and remained drop tight.

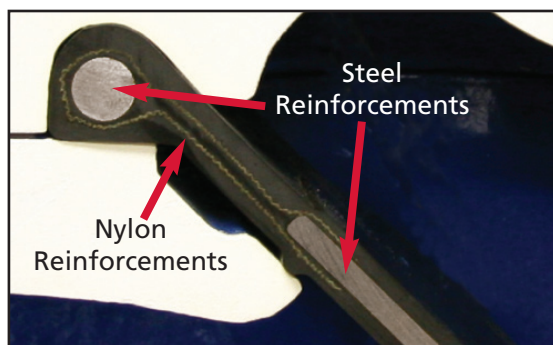

Figure 3. Reinforced Disc

## Advanced Technology

Incorporating the latest in valve technology assures a high-quality valve that will provide long service. The design process utilized Solid Modeling and Finite Element Analysis (FEA) of the key structural components. Flow and headloss data was derived from flow tests, mathematical models and Computational Fluid Dynamics (CFD). Manufacturing technology uses automated process control in the foundry and ISO 9001 controlled manufacturing processes.

## Product Certifications

Val-Matic Swing-Flex® check valves are certified for use in drinking water in accordance with NSF/ANSI 61 and are Certified Lead-Free per NSF/ANSI 372. Every valve is tested in accordance with AWWA C508. All valves are tested on automated hydraulic test rigs with gauges calibrated per ISO standards. All Val-Matic Valves are manufactured under a certified ISO 9001 quality management system.

# Ratings/Construction

## PRESSURE RATINGS

MAXIMUM PRESSURE RATINGS*		
SIZE RANGE in (mm)	CONNECTION	CWP psig (Bar)
2" - 24" (50-600 mm)	ANSI Class 125 Ductile Iron	250 (17.2)
30" - 48" (800-1200 mm)	ANSI Class 125 Cast Iron	150 (10.3)
30" - 48" (800-1200 mm)	ANSI Class 125 Ductile Iron	250 (17.2)

\*For Critical Low Pressure Applications, such as gravity flow and digester gas, low-durometer (soft rubber) discs are available. Consult Factory.

## MATERIALS OF CONSTRUCTION

COMPONENT	STANDARD	OPTIONAL
Body 2" - 24" (50-600 mm)	Ductile Iron ASTM A536, Grade 65-45-12	ASTM A351, CF8M 316 SS 3"-12" (80-300 mm)
Body 30" - 48" (800-1200 mm)	Ductile Iron ASTM A536, Grade 65-45-12	Cast Iron ASTM A126, Class B
Disc	Buna-N w/Alloy Steel & Nylon Reinforcement	EPDM, Hypalon, Viton
Coatings	Fusion Bonded Epoxy (Int/Ext)	Rubber Lining, Glass Lining
Mechanical Indicator (Optional)	17-4 Stainless Steel, Lead-Free Bronze	-
Backflow Actuator (Optional)	T304 Stainless Steel, Lead-Free Bronze	-
Oil Cushion 6" and larger (Optional)	17-4 Stainless Steel, Lead-Free Bronze	-

AWWA Note: If the purchaser specifies a wetted component that was not tested and certified to NSF/ANSI 61, the certification may not be valid.

# Headloss Chart

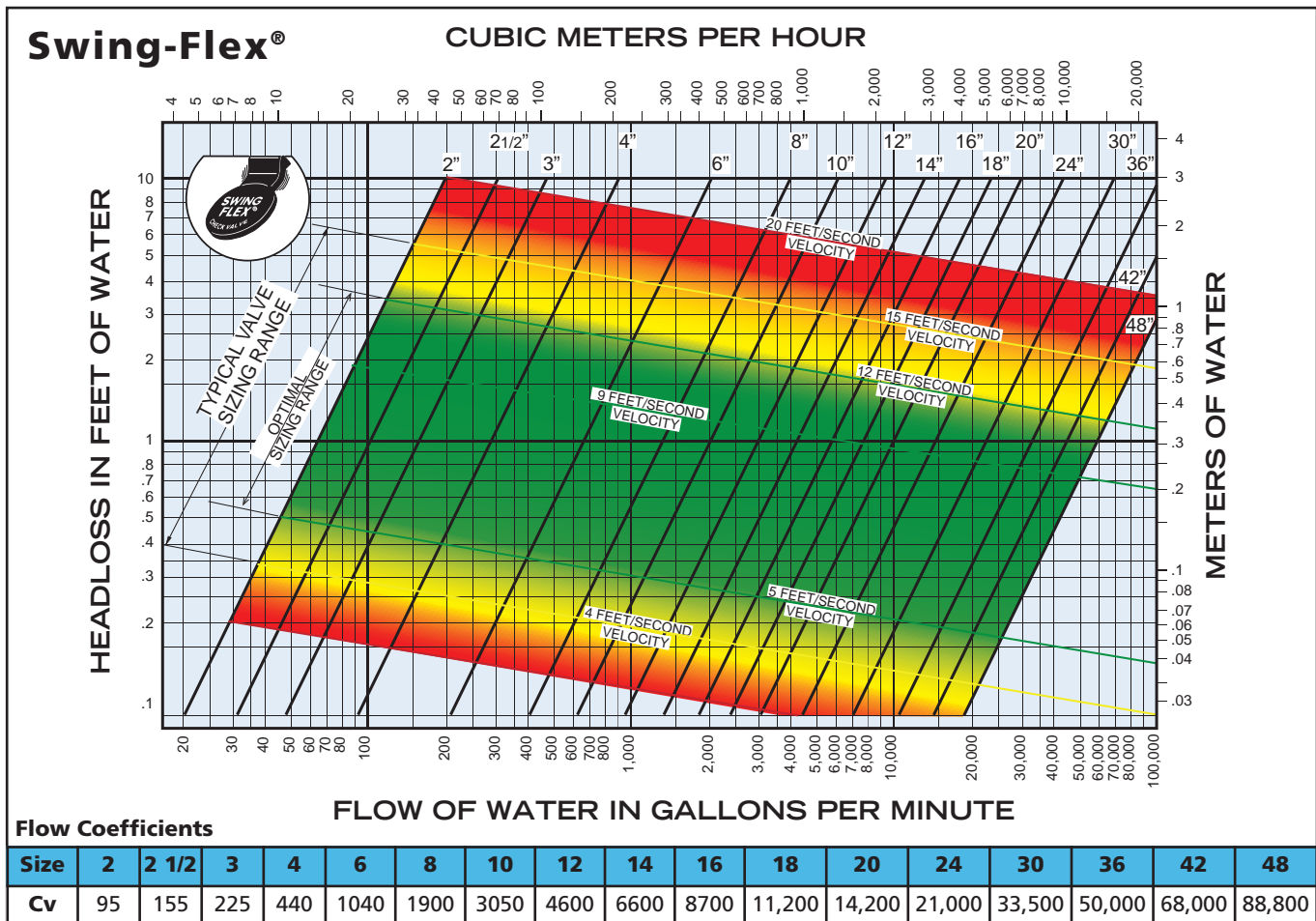

# Installation Dimensions

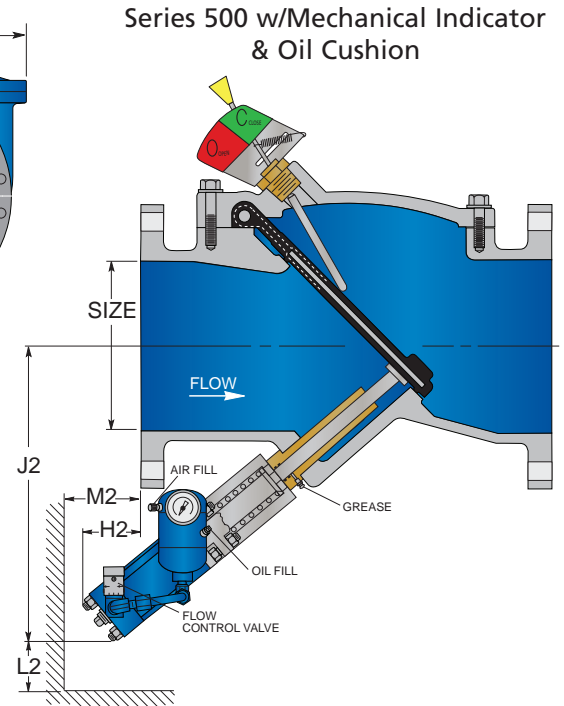
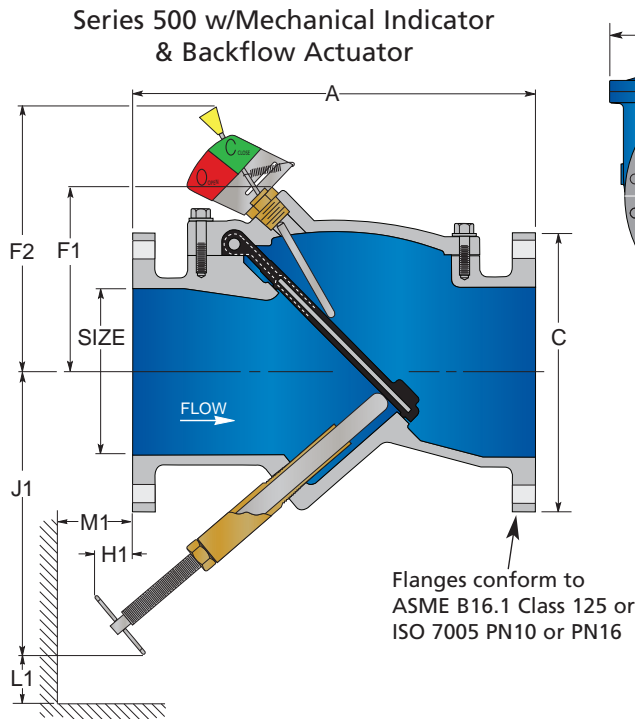

Dimensions in Inches

Valve Size (in)	Valve Size (mm)	CWP (PSI)	Base Valve				with Indicator	with Backflow Actuator				with Oil Cushion				
			Model No.	A	C	F1		K	F2	H1	J1	L1	M1	H2	J2	L2
2	50	250	502A	8.00	6.00	3.38	5.18	-	-0.50	6.75	1.50	1.50	-	-	-	-
2 1/2	60	250	525A	8.50	7.00	3.38	5.18	-	-0.50	7.00	1.50	1.50	-	-	-	-
3	80	250	503A	9.50	7.50	5.13	7.50	8.69	-0.38	7.50	1.50	1.50	-	-	-	-
4	100	250	504A	11.50	9.00	5.75	8.25	10.63	3.38	10.75	2.50	2.50	-	-	-	-
6	150	250	506C	14.00	11.00	6.88	11.12	11.69	1.38	11.38	3.00	3.00	5.00	16.00	4.25	9.25
8	200	250	508A	19.50	13.50	8.38	16.00	13.25	2.00	15.75	5.75	5.75	3.25	17.00	5.25	8.50
10	250	250	510A	24.50	16.00	10.75	21.00	15.63	0.50	17.00	5.75	5.75	1.25	18.00	6.25	7.25
12	300	250	512A	27.50	19.00	12.50	24.00	17.19	3.50	22.50	6.50	6.50	2.00	20.75	7.25	9.50
14	350	250	514A	31.00	21.00	13.00	23.25	18.81	4.00	26.25	6.50	6.50	0.00	22.75	7.25	7.50
16	400	250	516C	36.00	23.50	14.25	25.25	19.06	4.63	30.00	6.50	6.50	-1.00	24.25	9.00	10.25
18	450	250	518C	40.00	25.00	15.25	28.25	20.25	5.25	33.75	6.50	6.50	-1.25	25.25	8.75	7.50
20	500	250	520A	40.00	27.50	16.88	30.63	21.69	5.88	37.50	8.00	8.00	-2.75	27.00	9.50	5.25
24	600	250	524A	48.00	32.00	19.25	36.00	24.50	1.81	45.00	8.00	8.00	-9.00	27.63	9.75	0.75
30	800	150	530	56.00	38.75	23.00	45.88	27.81	-0.63	41.25	8.00	8.00	-9.50	33.63	11.25	3.00
	800	250	530A													
36	900	150	536	63.00	46.00	27.38	55.00	32.63	-0.38	49.00	9.75	9.75	-8.25	33.75	15.25	3.00
	900	250	536A													
42	1000	150	542	70.00	53.00	36.88	60.18	39.63	-5.50	53.50	9.75	9.75	-14.00	46.00	14.25	1.50
	1000	250	542A													
48	1200	150	548	76.00	59.50	40.66	68.00	43.41	-2.90	41.98	10.00	10.00	-	-	-	-
	1200	250	548A													

# Installations



Swing-Flex® Check Valve installed in a Valve Vault



Swing-Flex® Check Valve with Mechanical Indicator installed in a Pump Station

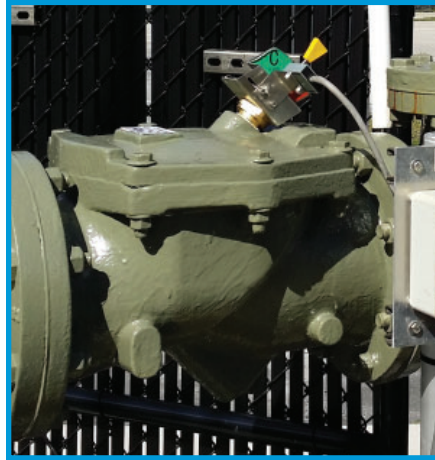

Swing-Flex® Check Valve with Limit Switch











Swing-Flex® Check Valve with Backflow Actuator and Air Valve for Pump Discharge



Swing-Flex® Check Valve with Oil Cushion for Pump Discharge

# Options/Accessories

Mechanical Disc Position Indicator	Limit Switch	Check Light	Backflow Actuator	Oil Cushion	Welded Nickel Seat	Tapped Ports	Rubber Lining	Glass Lining
Provides clear indication of the valve's disc position.	Used when applications require remote indication of valve's open/close position.	Provides remote indication from the limit switch.	Available for use when manual backflow operation is required.	Hydraulically controls the last 10% of valve closure in 1-5 seconds to reduce water hammer.	For severe and abrasive service.	Top and bottom NPT Ports for sampling, pressure testing, and removing sediment.	Interior lining suited for systems containing abrasive or corrosive fluids.	Interior lining provides a smooth, non-stick surface.
								

## SCOPE

- 1.1 This specification covers the design, manufacture, and testing of 2 in. (50 mm) through 48 in. (1200 mm) Swing-Flex® Check Valves suitable for cold working pressures up to 250 psig (1725 kPa), in water, wastewater, abrasive, and slurry service.
- 1.2 The check valve shall be of the full flow body type, with a domed access cover and only one moving part, the flexible disc.

## STANDARDS AND APPROVALS

- 2.1 The valves shall be designed, manufactured and tested to American Water Works Association Standard ANSI/AWWA C508.
- 2.2 The valves used in potable water service shall be certified to NSF/ANSI 61 Drinking Water System Components – Health Effects, and certified to be Lead-Free in accordance with NSF/ANSI 372.
- 2.3 Manufacturer shall have a quality management system that is certified to ISO 9001 by an accredited, certifying body.

## CONNECTIONS

- 3.1 The Valves shall be provided with flanges in accordance with ANSI B16.1, Class 125.

## DESIGN

- 4.1 The valve body shall be full flow area equal to nominal pipe diameter at all points through the valve. The 4 in. (100mm) valve shall be capable of passing a 3 in. (75mm) solid. The seating surface shall be on a 45 degree angle to minimize disc travel. A threaded port with pipe plug shall be provided on the bottom of the valve to allow for field installation of a backflow actuator or oil cushion device without special tools or removing the valve from the line.
- 4.2 The top access port shall be full size, allowing removal of the disc without removing the valve from the line. The access cover shall be domed in shape to provide flushing action over the disc for operating in lines containing high solids content. A threaded port with pipe plug shall be provided in the access cover to allow for field installation of a mechanical, disc position indicator.
- 4.3 The disc shall be of one-piece construction, precision molded with an integral O-ring type sealing surface and reinforced with alloy steel. The flex portion of the disc contains nylon reinforcement and shall be warranted for twenty-five years. Non-Slam closing characteristics shall be provided through a short 35 degree disc stroke and a memory disc return action to provide a cracking pressure of 0.25 psig.
- 4.4 The valve disc shall be cycle tested 1,000,000 times in accordance with ANSI/AWWA C508 and show no signs of wear, cracking, or distortion to the valve disc or seat and shall remain drop tight at both high and low pressures.

## MATERIALS

- 5.1 The valve body and cover shall be constructed of ASTM A536 Grade 65-45-12 ductile iron or ASTM A126 class B gray iron for 30 in. (800mm) and larger. Optional body materials include ASTM A-351 Grade CF8M, stainless steel for sizes 3" (80 mm) through 12" (300 mm).

- 5.2 The disc shall be precision molded Buna-N (NBR), ASTM D2000-BG. Optional disc material includes Viton, EPDM, Hypalon.

## OPTIONS

- 6.1 A screw-type backflow actuator shall be provided (when specified) to allow opening of the valve during no-flow conditions. Buna-N seals shall be used to seal the stainless steel stem in a Lead-Free bronze bushing. The backflow device shall be of the rising-stem type to indicate position. A stainless steel T-handle shall be provided for ease of operation.
- 6.2 A mechanical indicator shall be provided (when specified) to provide disc position indication on valves 3" (80 mm) and larger. The indicator shall have continuous contact with the disc under all operating conditions to assure accurate disc position indication.
- 6.3 A pre-wired limit switch will be provided (when specified) to indicate open/closed position to a remote location. The mechanical type limit switch shall be activated by the mechanical indicator. The switch shall be rated for NEMA 4, 6, or 6P and shall have U.L. rated 5 amp, 125 or 250 VAC contacts.
- 6.4 An oil cushion device shall be provided when specified to provide hydraulic control of the final 10% of valve closure and reduce valve slam and water hammer normally associated with rapid flow reversal conditions on pump shut down. The oil cushion device shall consist of a high pressure hydraulic cylinder, adjustable external flow control valve, oil reservoir, pressure gauge, stainless steel air inlet valve, and piping designed to control the closing speed of the last 10% of travel in 1-5 seconds. A threaded lead-free bronze dashpot bushing unit with a grease fitting for lubrication shall connect the cylinder to the valve and shall have an air gap to prevent hydraulic fluid from entering the valve and contaminating the water system. A snubber rod fitted with O-ring seals and rod wiper scrapers shall make contact with the lower portion of the disc's stainless steel strike plate.
- 6.5 Available linings include rubber for abrasive or corrosive fluids and glass for a smooth, non-stick surface.
- 6.6 A welded nickel seat is available for severe or abrasive service.

## MANUFACTURE

- 7.1 Manufacturer shall demonstrate a minimum of five (5) years' experience in the manufacture of resilient, flexible disc check valves with hydraulic cushions.
- 7.2 All valves shall be hydrostatically tested and seat tested to demonstrate zero leakage. When requested, the manufacturer shall provide test certificates, dimensional drawings, parts list drawings, and operation and maintenance manuals.
- 7.3 The exterior and interior of the valve shall be coated with an NSF/ANSI 61 approved fusion bonded epoxy coating.
- 7.4 Swing-Flex® Check Valves shall be Series #500 as manufactured by Val-Matic® Valve & Mfg. Corporation, Elmhurst, IL. USA or approved equal.



Val-Matic's quality of design and meticulous workmanship has set the standards by which all others are measured. Quality design features such as the AWWA **Ener-G® Ball Valve** with its energy efficient design, fusion bonded epoxy and adjustable resilient seating....**Cam-Centric® Plug Valves** have more requested features than any other eccentric plug valve....**American-BFV® Butterfly Valves** include a field replaceable seat without the need for special tools....**Tilted Disc® Check Valves** with high strength and wear resistant aluminum bronze trim as standard....**Silent Check Valves** featuring combined resilient/metal-to-metal seating and are **NSF/ANSI 61 & 372 Certified**....**Sure Seal Foot Valves** provided with a heavy duty stainless steel screened inlet....**Swing-Flex® and Surgebuster® Check Valves** designed with an unrestricted full flow area....**Swing Check Valves** with field adjustable closure

versatility....**Dual Disc® Check Valves** utilizing stabilized components to provide extended life....**Air Release, Air/Vacuum and Combination Air Valves** provided standard with Type 316 stainless steel trim....**VaultSafe®** family of products includes the **FloodSafe® Inflow Preventer, FrostSafe®** two-way damper and the **VentSafe®** vent pipe security cage. The **QuadroSphere® Trunnion Ball Valve** features a unique ball design with recessed surfaces creating additional flow paths to provide a self-cleaning action and reduced wear and torque.

Val-Matic is totally committed to providing the highest quality valves and outstanding service to our customers. Complete customer satisfaction is our goal. **Make the change to quality, specify Val-Matic!**



**Val-Matic Valve and Manufacturing Corp.**  
 905 Riverside Drive, Elmhurst, IL 60126  
 Phone: 630-941-7600 • Fax: 630-941-8042  
 www.valmatic.com • valves@valmatic.com